

Created By: AMH	Approved By: AMH	Sheet Size A	Sheet No. 1/8
Creation Date: 8/16/2022	Approval Date: 8/19/2022	Scale 1:1	Rev 1

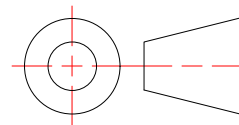

MF250 Assembly

Typical MF250 Installation, (1) MF250 Wall Rail, (1) MF250 Clip Shown

Weight: 2.517 lbmass

Finish: Mill



MONARCH
METAL INC.

PROPRIETARY AND CONFIDENTIAL

THE INFORMATION CONTAINED IN THIS DRAWING IS THE SOLE PROPERTY OF MONARCH METAL FABRICATION. ANY REPRODUCTION IN PART OR AS A WHOLE WITHOUT THE WRITTEN PERMISSION OF MONARCH METAL INC. IS PROHIBITED.

New York
1700 Ocean Ave Suite 2
Ronkonkoma NY 11779
Phone: (631) 750-3000

Nevada
1080 Linda Way, Unit 10
Sparks, NV 89431
Phone: (775) 415-0100

Texas
1330 Post & Paddock St.,
Suite 800
Grand Prairie, TX 75050
(945) 202-2700

monarchmetal.com

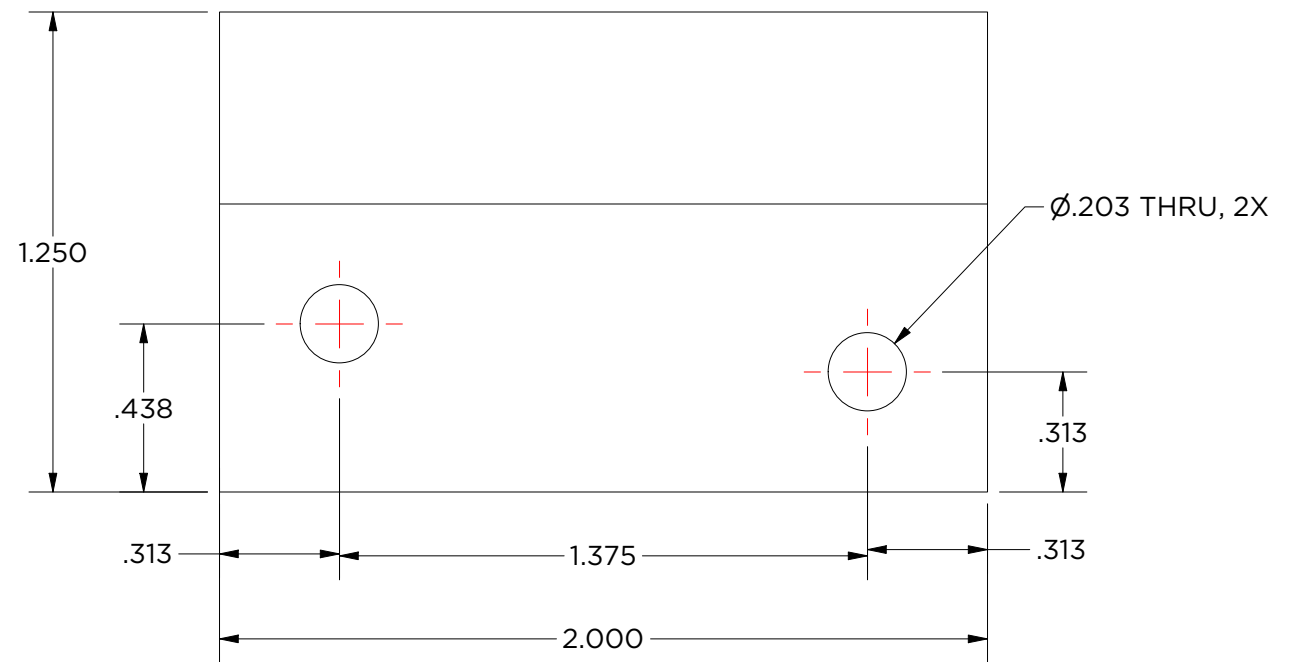
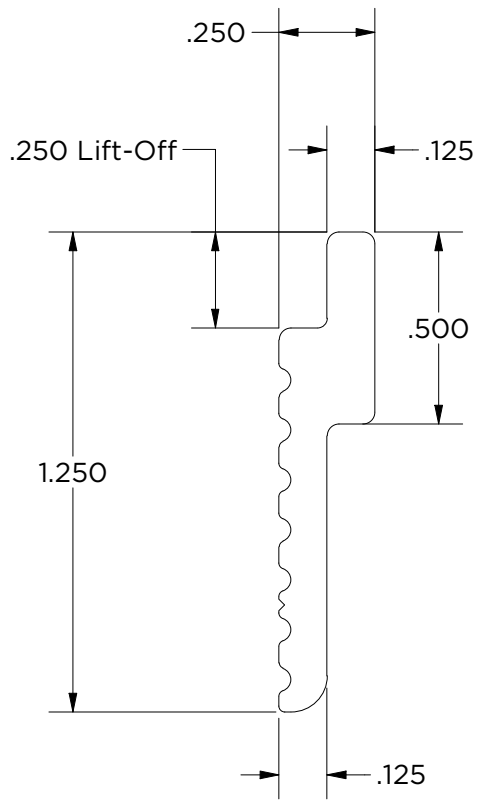

Created By: AMH	Approved By: AMH	Sheet Size A	Sheet No. 2/8
Creation Date: 8/16/2022	Approval Date: 8/19/2022	Scale 2 : 1	Rev 1

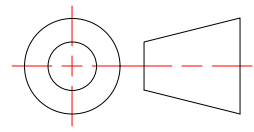

MF250-2
 Weight: 0.033 lbmass
 Aluminum 6063-T6
 Finish: Mill



MONARCH
METAL INC.

PROPRIETARY AND CONFIDENTIAL
 THE INFORMATION CONTAINED IN THIS DRAWING IS THE SOLE PROPERTY OF MONARCH METAL FABRICATION. ANY REPRODUCTION IN PART OR AS A WHOLE WITHOUT THE WRITTEN PERMISSION OF MONARCH METAL INC. IS PROHIBITED.

New York 1700 Ocean Ave Suite 2 Ronkonkoma NY 11779 Phone: (631) 750-3000
Nevada 1080 Linda Way, Unit 10 Sparks, NV 89431 Phone: (775) 415-0100
Texas 1330 Post & Paddock St., Suite 800 Grand Prairie, TX 75050 (945) 202-2700

monarchmetal.com

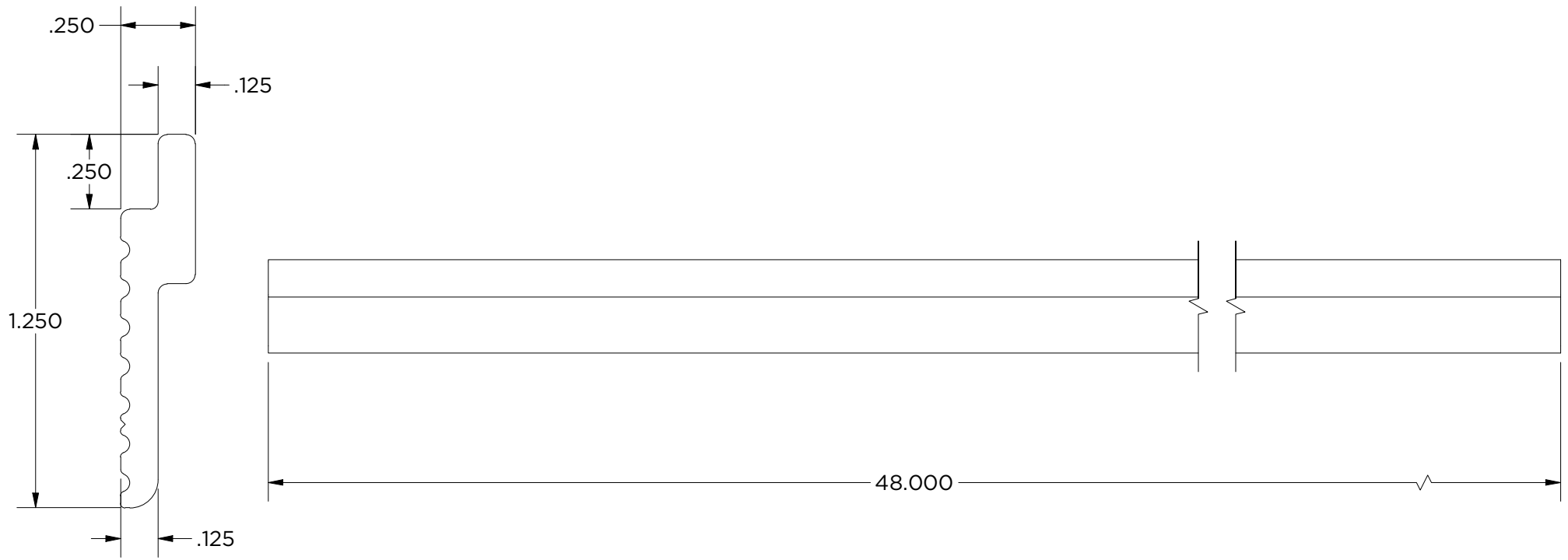

Created By: AMH	Approved By: AMH	Sheet Size A	Sheet No. 3/8
Creation Date: 8/16/2022	Approval Date: 8/19/2022	Scale 1 / 2	Rev 1

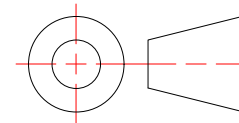

MF250-48

Weight: 0.814 lbmass
Aluminum 6063-T6
Finish: Mill



MONARCH
METAL INC.

PROPRIETARY AND CONFIDENTIAL

THE INFORMATION CONTAINED IN THIS DRAWING IS THE SOLE PROPERTY OF MONARCH METAL FABRICATION. ANY REPRODUCTION IN PART OR AS A WHOLE WITHOUT THE WRITTEN PERMISSION OF MONARCH METAL INC. IS PROHIBITED.

New York
1700 Ocean Ave Suite 2
Ronkonkoma NY 11779
Phone: (631) 750-3000

Nevada
1080 Linda Way, Unit 10
Sparks, NV 89431
Phone: (775) 415-0100

Texas
1330 Post & Paddock St.,
Suite 800
Grand Prairie, TX 75050
(945) 202-2700

monarchmetal.com

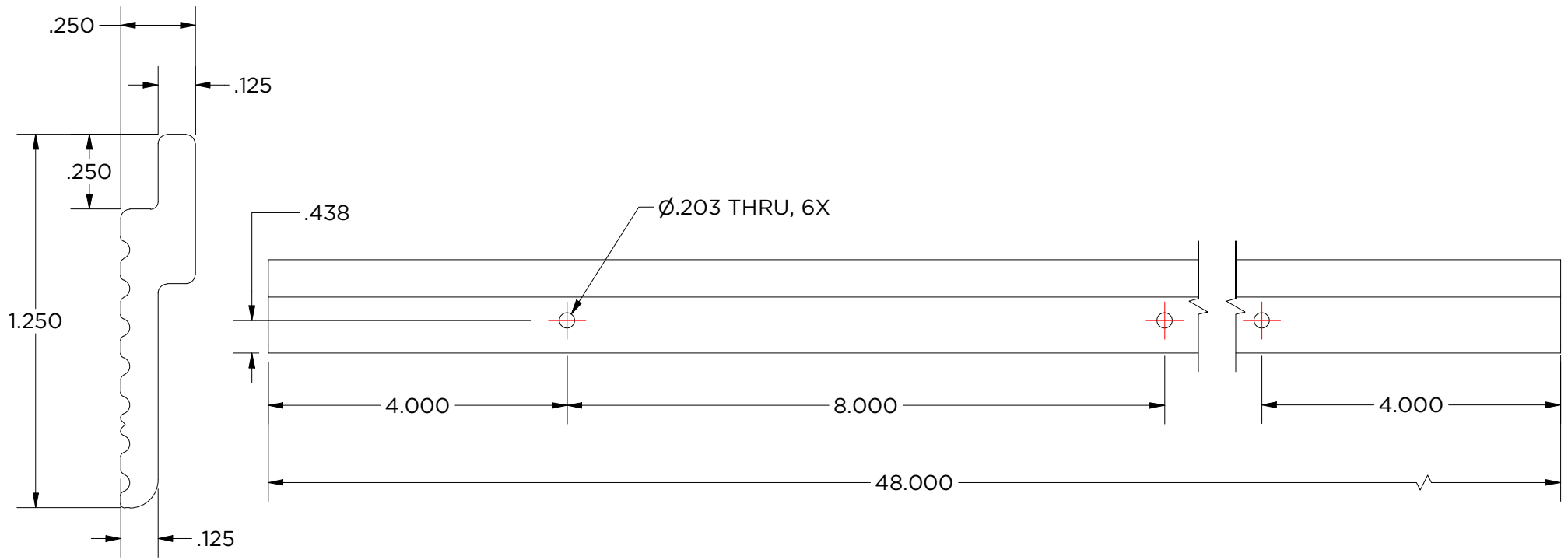

Created By: AMH	Approved By: AMH	Sheet Size A	Sheet No. 4/8
Creation Date: 8/16/2022	Approval Date: 8/19/2022	Scale 2 : 1	Rev 1

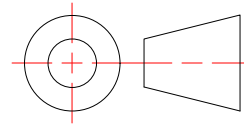

MF250-48H8

Weight: 0.812 lbmass
Aluminum 6063-T6
Finish: Mill



MONARCH
METAL INC.

PROPRIETARY AND CONFIDENTIAL

THE INFORMATION CONTAINED IN THIS DRAWING IS THE SOLE PROPERTY OF MONARCH METAL FABRICATION. ANY REPRODUCTION IN PART OR AS A WHOLE WITHOUT THE WRITTEN PERMISSION OF MONARCH METAL INC. IS PROHIBITED.

New York
1700 Ocean Ave Suite 2
Ronkonkoma NY 11779
Phone: (631) 750-3000

Nevada
1080 Linda Way, Unit 10
Sparks, NV 89431
Phone: (775) 415-0100

Texas
1330 Post & Paddock St.,
Suite 800
Grand Prairie, TX 75050
(945) 202-2700

monarchmetal.com

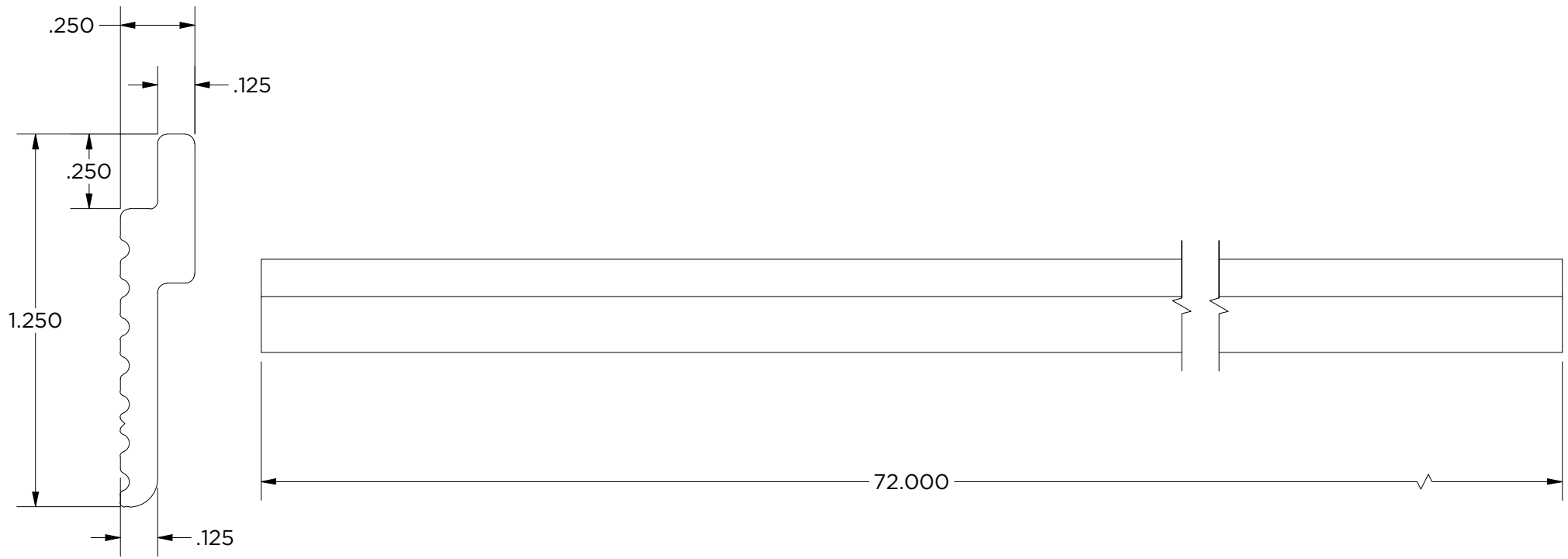

Created By: AMH	Approved By: AMH	Sheet Size A	Sheet No. 5/8
Creation Date: 8/16/2022	Approval Date: 8/19/2022	Scale 1 / 2	Rev 1

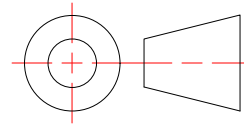

MF250-72

Weight: 1.221 lbmass
Aluminum 6063-T6
Finish: Mill



MONARCH
METAL INC.

PROPRIETARY AND CONFIDENTIAL

THE INFORMATION CONTAINED IN THIS DRAWING IS THE SOLE PROPERTY OF MONARCH METAL FABRICATION. ANY REPRODUCTION IN PART OR AS A WHOLE WITHOUT THE WRITTEN PERMISSION OF MONARCH METAL INC. IS PROHIBITED.

New York
1700 Ocean Ave Suite 2
Ronkonkoma NY 11779
Phone: (631) 750-3000

Nevada
1080 Linda Way, Unit 10
Sparks, NV 89431
Phone: (775) 415-0100

Texas
1330 Post & Paddock St.,
Suite 800
Grand Prairie, TX 75050
(945) 202-2700

monarchmetal.com

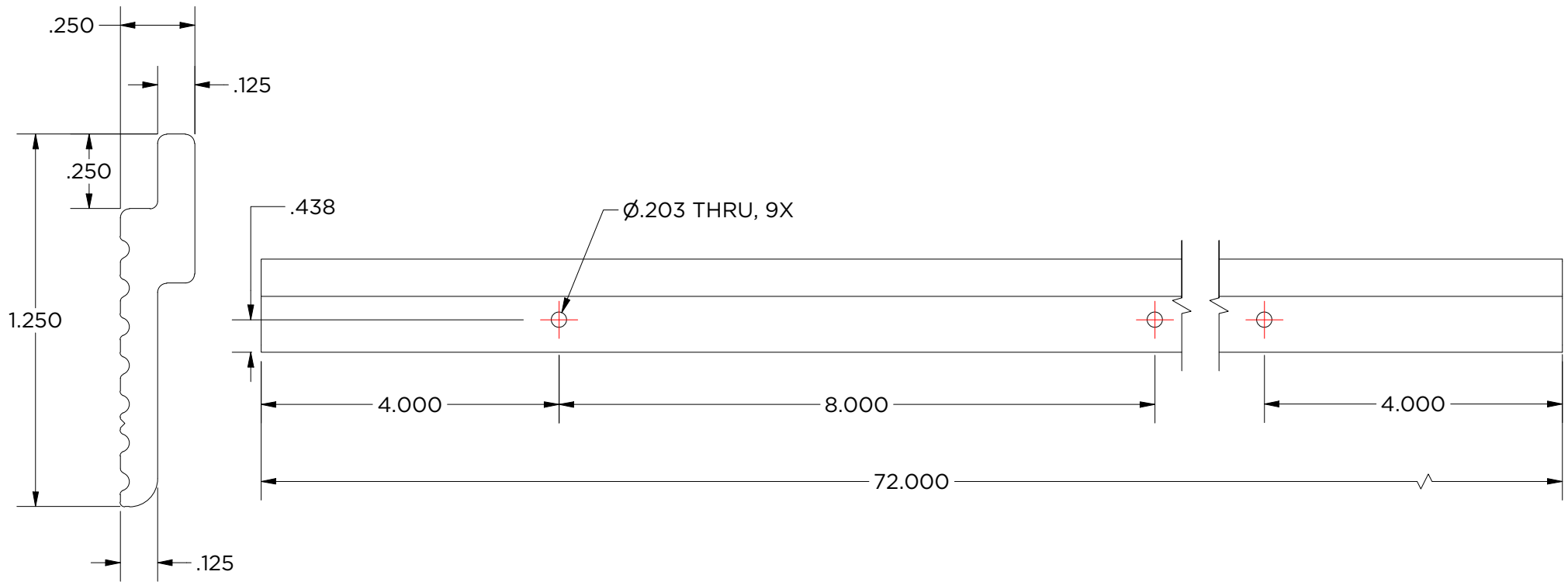

Created By: AMH	Approved By: AMH	Sheet Size A	Sheet No. 6/8
Creation Date: 8/16/2022	Approval Date: 8/19/2022	Scale 2 : 1	Rev 1

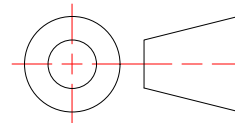

MF250-72H8

Weight: 1.218 lbmass
Aluminum 6063-T6
Finish: Mill



MONARCH
METAL INC.

PROPRIETARY AND CONFIDENTIAL

THE INFORMATION CONTAINED IN THIS DRAWING IS THE SOLE PROPERTY OF MONARCH METAL FABRICATION. ANY REPRODUCTION IN PART OR AS A WHOLE WITHOUT THE WRITTEN PERMISSION OF MONARCH METAL INC. IS PROHIBITED.

New York
1700 Ocean Ave Suite 2
Ronkonkoma NY 11779
Phone: (631) 750-3000

Nevada
1080 Linda Way, Unit 10
Sparks, NV 89431
Phone: (775) 415-0100

Texas
1330 Post & Paddock St.,
Suite 800
Grand Prairie, TX 75050
(945) 202-2700

monarchmetal.com

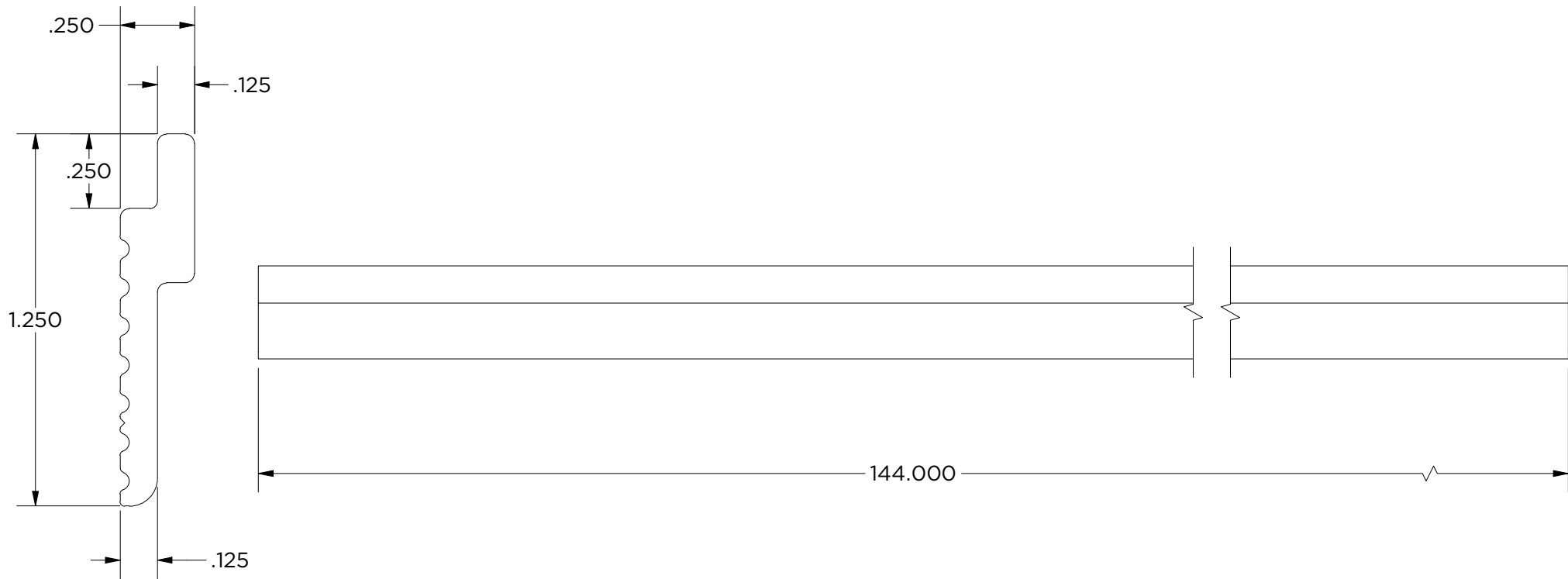

Created By: AMH	Approved By: AMH	Sheet Size A	Sheet No. 7/8
Creation Date: 8/16/2022	Approval Date: 8/19/2022	Scale 1 / 2	Rev 1

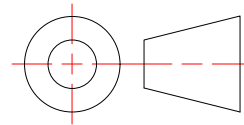

MF250-144

Weight: 2.442 lbmass
Aluminum 6063-T6
Finish: Mill



MONARCH
METAL INC.

PROPRIETARY AND CONFIDENTIAL

THE INFORMATION CONTAINED IN THIS DRAWING IS THE SOLE PROPERTY OF MONARCH METAL FABRICATION. ANY REPRODUCTION IN PART OR AS A WHOLE WITHOUT THE WRITTEN PERMISSION OF MONARCH METAL INC. IS PROHIBITED.

New York
1700 Ocean Ave Suite 2
Ronkonkoma NY 11779
Phone: (631) 750-3000

Nevada
1080 Linda Way, Unit 10
Sparks, NV 89431
Phone: (775) 415-0100

Texas
1330 Post & Paddock St.,
Suite 800
Grand Prairie, TX 75050
(945) 202-2700

monarchmetal.com

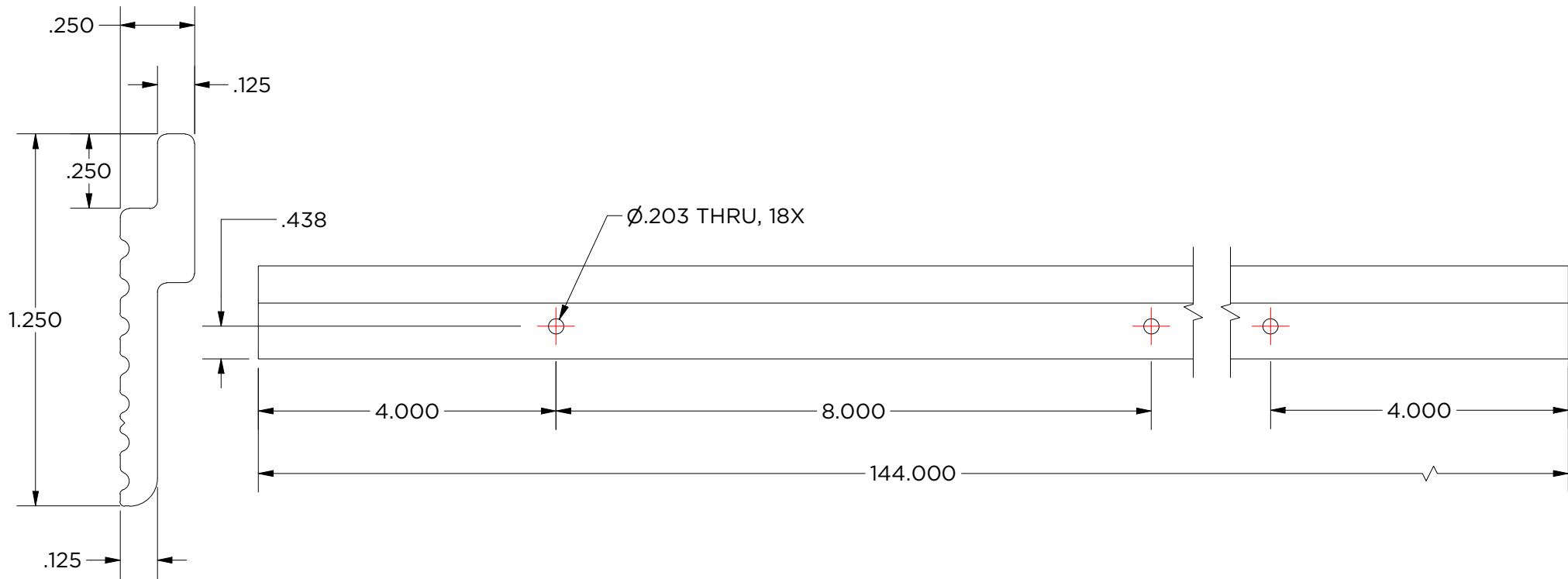

Created By: AMH	Approved By: AMH	Sheet Size A	Sheet No. 8/8
Creation Date: 8/16/2022	Approval Date: 8/19/2022	Scale 1 / 2	Rev 1

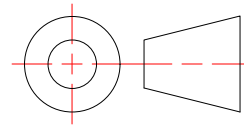

MF250-144H8

Weight: 2.435 lbmass
Aluminum 6063-T6
Finish: Mill



MONARCH
METAL INC.

PROPRIETARY AND CONFIDENTIAL

THE INFORMATION CONTAINED IN THIS DRAWING IS THE SOLE PROPERTY OF MONARCH METAL FABRICATION. ANY REPRODUCTION IN PART OR AS A WHOLE WITHOUT THE WRITTEN PERMISSION OF MONARCH METAL INC. IS PROHIBITED.

New York
1700 Ocean Ave Suite 2
Ronkonkoma NY 11779
Phone: (631) 750-3000

Nevada
1080 Linda Way, Unit 10
Sparks, NV 89431
Phone: (775) 415-0100

Texas
1330 Post & Paddock St.,
Suite 800
Grand Prairie, TX 75050
(945) 202-2700

monarchmetal.com